

GC Optima-3007

Gas Chromatograph



EPCC / PRODUCTS / APPLICATION / SOFTWARE / ACCESSORIES / CONSUMABLES / SERVICES

Analytical Technologies Limited

An ISO 9001 Certified Company

www.analyticalgroup.net

Instrument feature

- One button access to routine maintenance information.
- PCM control module much precise with independent-development AFC system;
- Instant Connect Auxiliary Temperature Module with 8-channel high-accuracy temperature control system and 8-channel outside events to fulfill fulfill counter-control
- Every gas circuit can achieve constant-pressure, constant-flow, constant-speed, programmable-temperature-rise, programmable-flow-rise and programmable-speed-rise;
- Unlimited valve events to fulfill accurate switching of multi-valve;
- Outside power & voltage checking system, over-heating protection system and flow monitoring system to make it intellectualized.
- Vacuum fluorescent display with english.
- Multi-function keyboard can set complicated parameters and store 16 chromatography method;
- FID and FPD can provide reminder for auto ignite and turn-off, TCD with overflow/cut-off protection, flameout detection.
- Excellent FID wide-range to enhance linear range;
- Multi-valve and multi-column switch system to make sure complicated analysis at one times injection;
- PCB system shielding function to reduce interference;
- Carrier gas saving mode available to reduce cost;
- Autosampler, headspace and thermal desorption can be incorporated;
Analchrom workstation can fulfill 3Q certification to meet GMP/GLPstandard.
- GC is capable of upgradation to any 3rd detector or mass Detector.
Built in display and computer interface, display chromatograms, method parameters like temp., pressure and flow rates etc.
Automatic evaluate and store the column pneumatic resistance.
- Capable to calculate the carrier gas linear velocity and the column void information
- Automatic ignition and re-ignition of FID flame through keyboard or software
- Capable to measure disinfection by products (THMs, HAAs etc.), pharmaceutically active compounds, polycyclic aromatic compounds etc.

EPC/AFC Gas system

AFC: split/splitless mode, carrier gas can fulfill constant-pressure, constant-flow, constant-speed, programmable-temperature-rise, programmable-flow-rise and programmable-speed-rise to reduce sample decomposition and discrimination while increase separation and shorten analysis time.

EPCAFC fulfill digitalization and automatization, only need input column parameters, EPC/AFC can set best flow of column and show digitally.

EPC/AFC can fulfill gas leaking self-diagnosis and cut off flow & gas source and alarm at the same time.

Carrier and makeup gas setting selectable for He, H₂, N₂, and Ar, Psi, KPa, Bar units selectable

Pressure control range: 0-150Psi, Pressure accuracy:0.001Psi, Programmable pressure ramps.

Flow range control range: 0-600ml/min up to 1250ml/min

Pressure set points adjustable in increments of 0.001 psi

Make up gas(purge flow): 0 to 50 ml/min or better

Retention time repeatability: 0.008 min

Peak area repeatability: <0.5% RSD time events: 7

Carrier gas flow: 0.1ml/min to 100ml/min

Split flow setting: 0.1 ml/min to 400ml/min

Oxygen: 0.1 to 400ml/min, Hydrogen: 0.1 to 150 ml/min, Carrier gas: 0.1 to 150 ml/min

Clarity workstation feature

- Multi-channel and multi-user universal workstation to control all parameter Can collect signal from 4 detectors via RS232 or USB
- Basic parameter: max sample-collecting frequency @100Hz/unlimited peak process quantity/integral sensitivity @1μV*s
Batch processing makes machine control, auto sampling sequence collecting, auto integral correction much easier auto integral correction much easier
- Fully support FDA-21CFR PART 11, SST AND IQ/OQ
- Powerful post-treatment facilitate chromatography comparing, re-correction and data input&output.
- Feature like easy to use report publisher, online help and answer, fully compatible with windows 7/10.
Offers minimum sampling time snapshot function, single analysis capability. Automatic and manual peak integration, manipulation, identification, calibration points and levels and manual calibration curve creation, column performance calibration, data comparison function etc.
- LAN
- Windows XP/7 support
- Singnal capture from 2 detectors simultaneously
Sampling frequency: 100Hz

- Sampling Speed: 50 times/sec
- Unlimited peak quantity
- Self-diagnosis: intelligent automatic error identification and self-protection
- Can compatible with Clarity to fully support FDA-21CFR part 11, SST and IQ/OQ.

Inlets

Packed purge injection port (PIIP)

Split/splitless capillary port (S/SL)

1) Max Temperature: 550°

2) Split ratio: 12500:1

3) Modes: Constant pressure and flow modes

4) Gas saver mode to reduce gas consumption without compromise performance

5) Programmable Temp./Pressure ramp: 8 steps

6) Valve injection is available

7) Pressure range: 0–1000 kPa (0–150 psi)

8) User-installable within a few minutes.

9) Material of construction: Stainless steel

System Capability

- Assembly simultaneously: 2 inlets +3 detectors (FID, TCD, ECD, FPD and NPD)
- Automatic control can be done from local keyboard and networked PC
- Carrier gas control: EPC/AFC
- Automatic liquid sampling available
- Heated zones up to 7 with GC
- 63 user-selectable events
- Support Multivalve with auxiliary oven
- Operating altitude up to 3500 m above sea level

Basic info

- Voltage: 220V± 10%, 50Hz
- Power: 3000W
- Net dimension 645 x 500 x 555mm
- Net weight: 55Kg
- Operating temperature: 15 to 35°C and 10-90% Non-Condensing

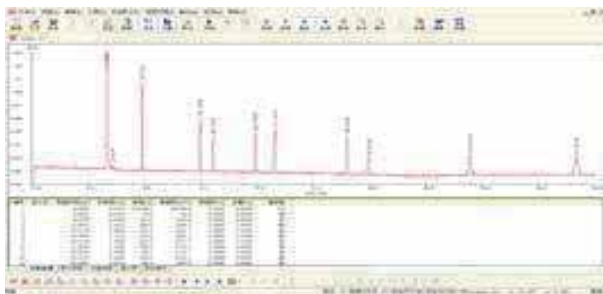

Traditional GC(Column temp @140°C) Analysis time 43min

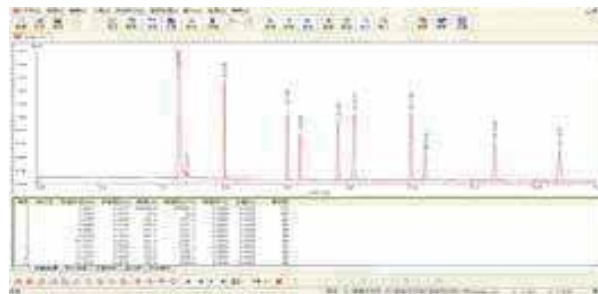

Optima-3007 (Column temp @140°C) with programmable pressure-rise Analysis time 17min

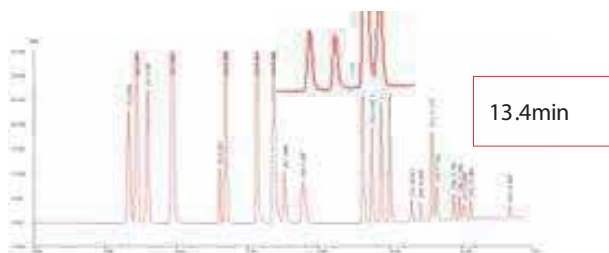

Traditional GC constant-flow mode Analysis time 13.4min

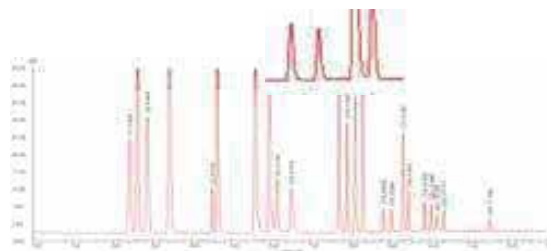

Optima-3007 with programmable pressure-rise Analysis time 17min

Carrier gas saving mode:
After injection, can proceed low split flow mode automatically to reduce carrier gas significantly.

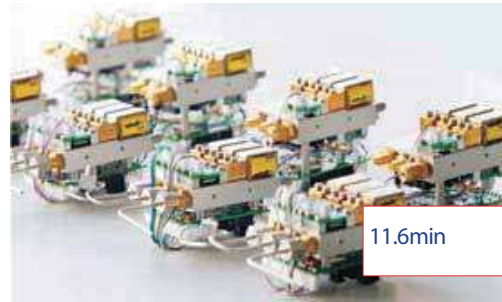

Multi-valve and multi-column switch

Adopting AFP pneumatic valve, can setup 3-valve- 4-column and 4-valve- 5- column switch system to fully analyze only at one time sinpetro chemical, coalgas, trace C₂H₂ inethylene and trace CO and CO₂ in ethylene.

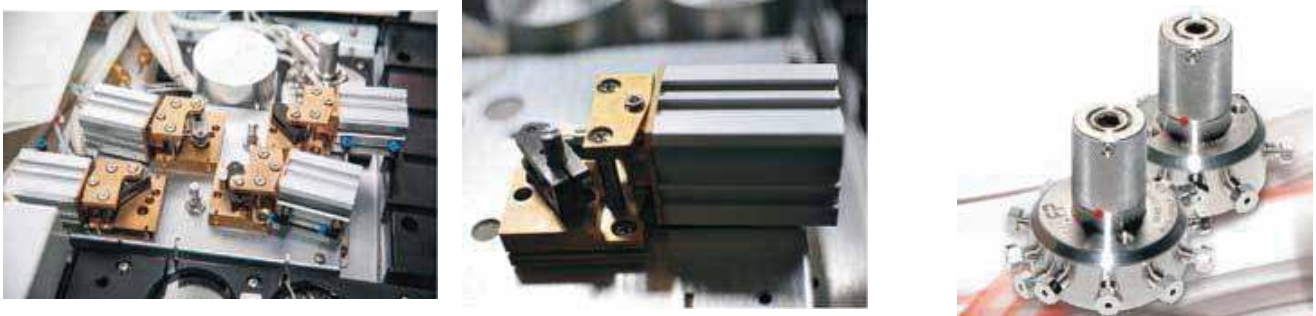

Multi-valve and multi-column flow diagram

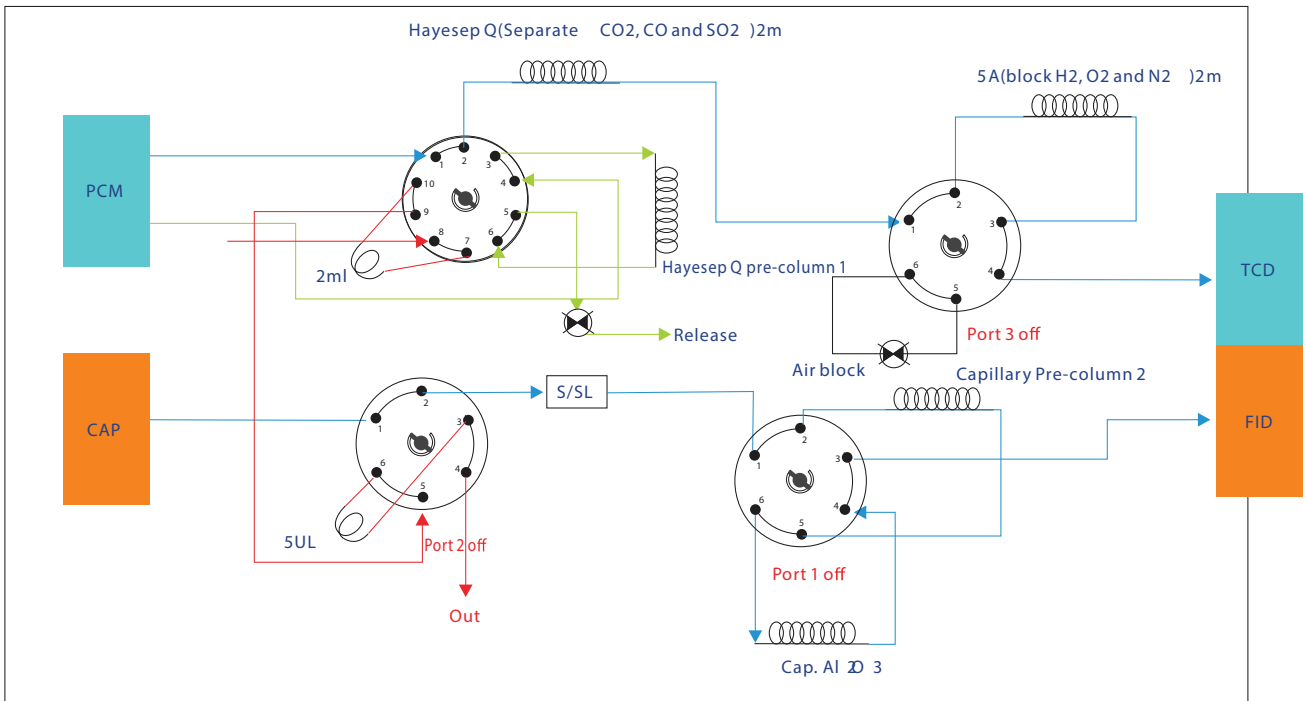

Clarity workstation is applicable

- ▶ Multi-channel and multi-user universal workstation to control all parameter
- ▶ Can collect signal from 4 detectors via RS232 or USB
- ▶ Basic parameter: max sample-collecting frequency @100Hz/unlimited peak process quantity/integral sensitivity @1 μ V*s
- ▶ Batch processing makes machine control, auto sampling sequence collecting, auto integral correction much easier
- ▶ Fully support FDA-21CFR PART11, S STAND IQ/OQ
- ▶ Powerful post-treatment facilitate chromatography comparing, re-correction and data input & output.
- Fully counter-control to set all parameter in workstation
- Easy operational
- Multi-channel signal sampling, multi outside events control



Autosampler for optima-3007

Vial capacity: 2 mL (Optional micro-volume vials: 300 μ L)

Big displayer with double -tower automatic injection;

Tray vial quantity: 16 or 150;

Injection volume: 0.1-100 μ L;

Sampling accuracy: +0.01 μ L;

Injection Port: split/splitless capillary

Injection needle: 5, 10, 50, 100 μ L;

Injection loop: multiport(0.25ml, 0.5ml and 1ml)

Injection repeatability: <0.5%

Maximum Temperature: 450°C)

Temp. Contrl range: RT+5°C ~ 450°C (0.1°C increment)

Maximum pressure: 0-150psi(with EPC)

Vial volume: 10 ml to 22 ml

Transfer line based with loop system for precise quantification

Transfer Line to the GC temperature range: 50 to 200 Degree

Automatic leak check and gas saving facility.

system heating up to 200°C or better in increments of 1°C with shaker or better.

100 sample vial capacity



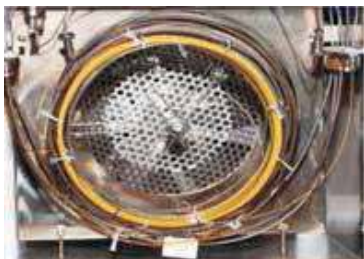

Column oven dimension: 278x310x165mm=15L; accommodate up to 2pcs
105m x 0.53mm ID capillary column

Temp. control cool down range: RT+4°C~550°C(0.1°C increment)

Temperature Ramp: multi-ramp(>20)with 21 plateaus

Temperature set point Resolution: 0.1°C

Programming heat temp.-ramp speed: 0-125°C/min

Programming temp.-ramp : any step;

Fast cool down: 450~50°C ≤3.5min

Temp. accuracy: 0.1°C.

Max run time: 999.99 minutes

Ambient rejection : <0.01°C per 1°C

The oven temperature stability is within 0.01°C / every °C of actual temperature

Cryogenic option minimum temperature: -100°C with liquid nitrogen;

-50°C with liquid CO₂



Wide split ratio setting range;

Max capillary split ratio: 12500:1;

Packed injection, capillary injection, flash-evaporation

injection, PTV injection and liquid injection are available;

Easy consumables changeover .



Excellent wide range FID design, no ceiling limit for solvent peak;

Limit of detection can be <1.5 pgC/s

Ignition recognition, H₂protection, anti-ponding;

Solvent no tailing peak.

Sensitivity: >0.03 Coulombs/gC

Data Acquisition Rate: up to 300Hz

Compatible with 1/4", 1/8", 1/16" capillary columns

Can incorporate flash-evaporation and high pressure liquid injection

Flash-evaporation injection for gas-liquid mixture, high pressure valve injection for liquid.

PTV sample injection

With multiple accumulated injection and solvent release, increase temperature program-rise to achieve trace analysis.



Carrier and makeup gas settings selectable for He, H₂, N₂ and Ar

Psi, KPa, Bar units selectable

Pressure control range: 0~150Psi, Pressure accuracy: 0.001Psi
Programmable pressure ramp RSD \leq 0.5%

Flow rate control range: 0~600ml/min upto 1000ml/min , flow rate accuracy: 0.1ml/min
flow rate RSD \leq 0.1%

programmable pressure/flow rate ramping: 20 steps

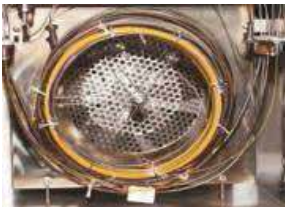

Column oven dimension: 278x 310x 165mm=15L

Temp. Contrl range: RT+5°C ~ 450°C (0.1°C in crement)

Programming temp. - ramp speed : 0-125°C/min

Programming temp.-ramp : any stap

Fast cool down: 450~50°C \leq

Temp. accuracy: \pm 0.1°C

Flow sensor accuracy: \leq +3%, detector module accuracy: <+7%

Detector	Max operating temp.	Limit of detection	Baseline noise	Baseline drift (after 2hrs stabilization)	Linear dynamic range
FID	450°C	≤1.5 pgC/s (N-C16)	≤2 x 10 ⁻¹⁴ A	5 x 10 ⁻¹⁴ A/30min	≥ 10 ⁷
TCD	400°C	≥ 400 pg/ml (N-C16)	≤30uV	≤ 100uV /30min	≥ 10 ⁵
ECD	400°C	≤ 3 x 10 ⁻¹⁴ pg/ml (Y-666)	≤20uV	≤ 50uV /30min	≥ 10 ⁴
FPD	400°C	S: 100 x 10 ⁻¹⁴ g/s P: ≤5.0 x 10 ⁻¹² g/s or 2.0 x 10 ⁻¹³ g/s	S: ≤2 x 10 ⁻¹³ A P: ≤8 x 10 ⁻¹³ A	S: ≤1 x 10 ⁻¹² A/30min P: ≤2 x 10 ⁻¹² A/30min	S ≥ 10 ² P: ≥ 10 ³
NPD	400°C	N: ≤1 x 10 ⁻¹² g/s(Azobenzene) P: ≤5 x 10 ⁻¹³ g/s(Malathion)	≤4 x 10 ⁻¹³ A	2 x 10 ⁻¹² A/30min	N: ≥ 10 ³ P: ≥ 10 ³

Standard setup	Capillary inlet	Split/splitless capillary
	Packed inlet	Packed inlet
	Workstation	Optima-3007 or Analchrom counter-control workstation
Optional sampling device	Injection Valve	6 - port valve or 10-port valve
	Headspace sampler	Available
	Thermal desorption	Available
	Auto sampler	16 or 150

Performance introduction INSTRUMENTS PERFORMANCE IS INTRODUCED

Excellent qualitative repeatability

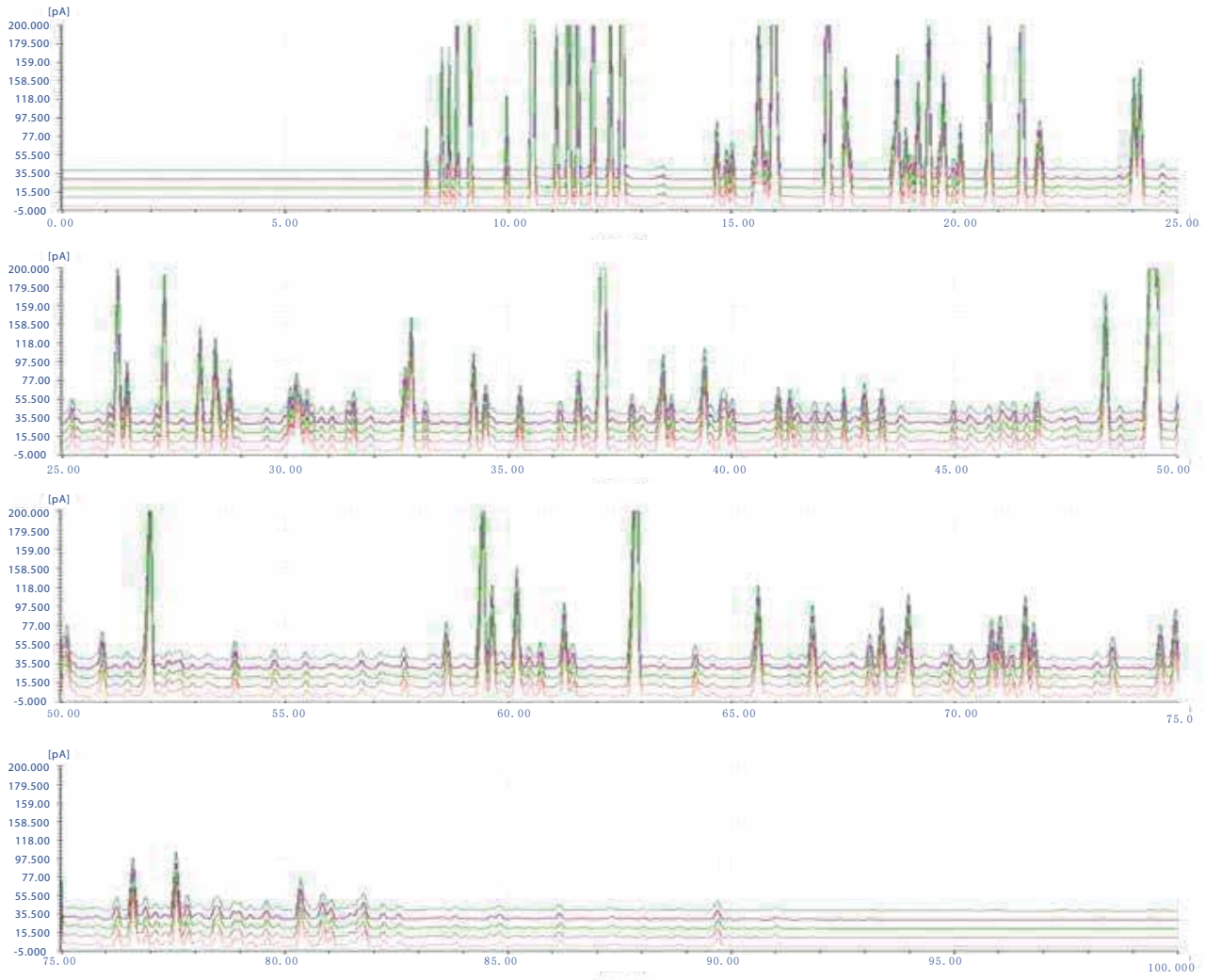

Excellent quantitative repeatability

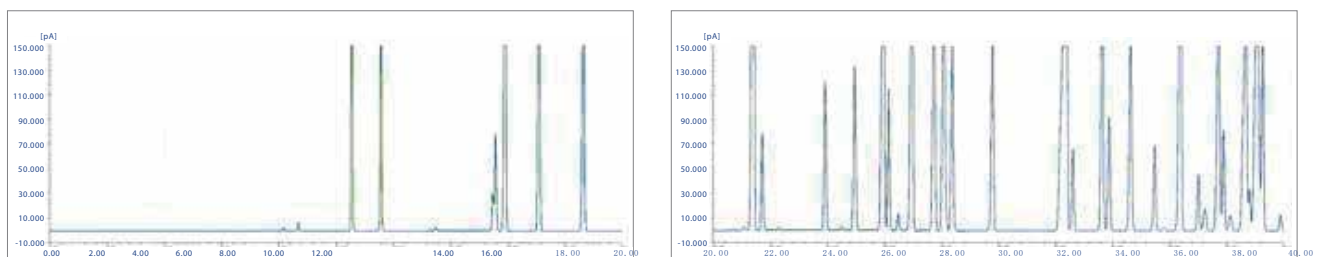

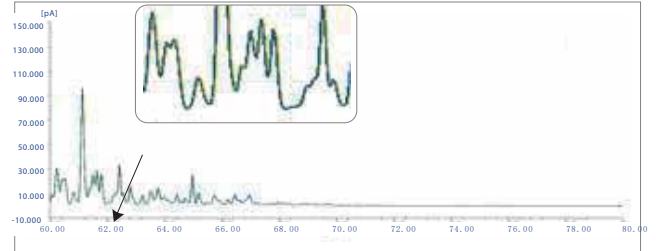
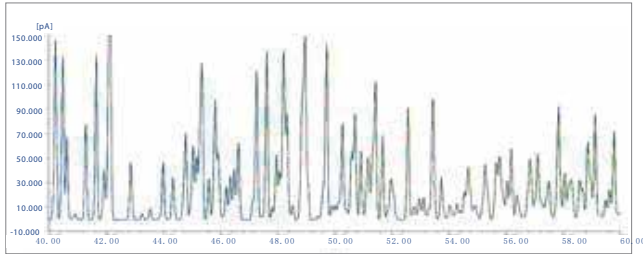

Excellent wide-range design makes no ceiling limit of solvent peak

300ppm FIDstandard sample

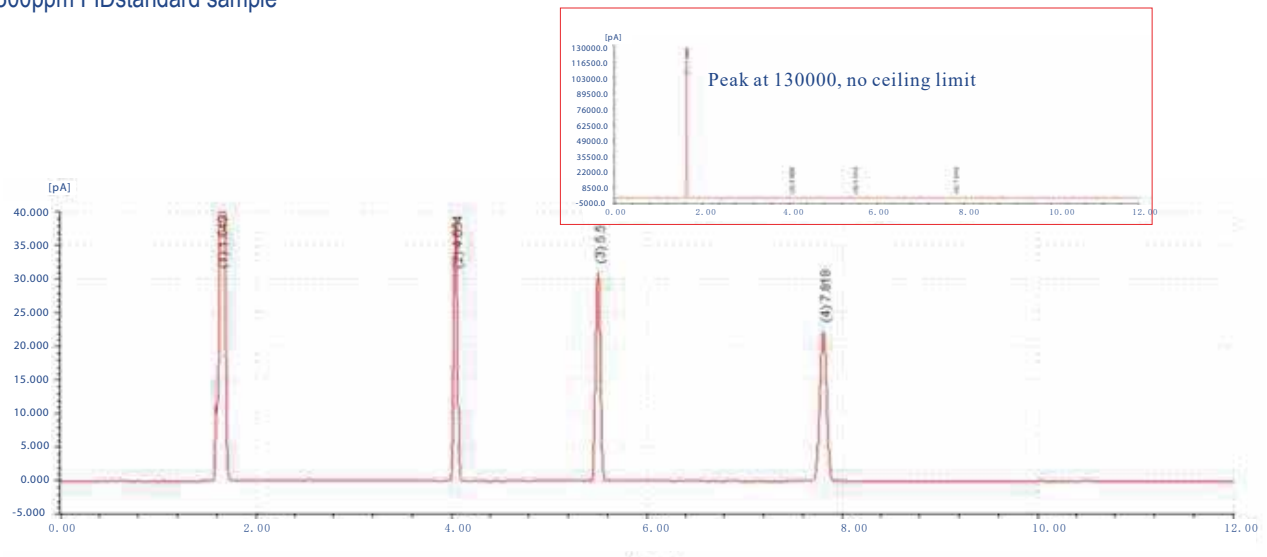

Typical application

GC-3007 is suitable but no limited to below application: food safety, environmental protection, energy(), medicine Petroleum refining industry and etc.

【Food safety】

Chinse white wine

Setup

Detector: FID
Inlet: Capillary
Gas control module: 2 sets
Injection mode: liquid autosampler
Column: LZP950 for wine
Workstation: Optima-3007

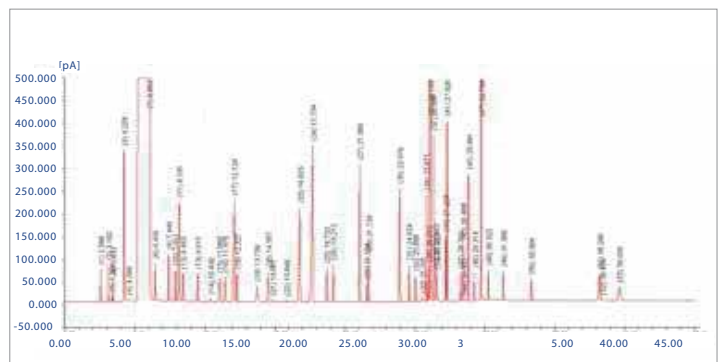

DEHP(Di-(2-ethylhexyl)phthalate)

Setup

Detector: FID
Inlet: Capillary
Gas control module: 2 sets
Injection mode: liquid autosampler
Column: HP-5 cap.
Workstation: Optima-3007

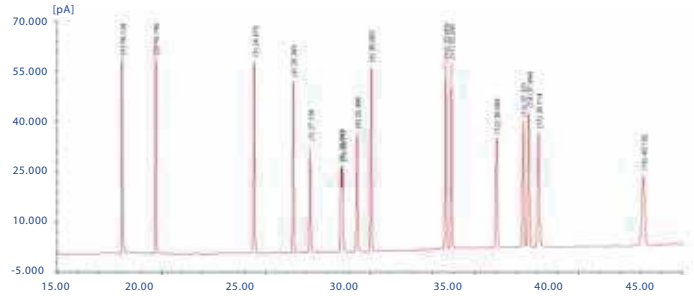

200ppb organochlorine in pesticide residue

Setup

Detector: ECD
Inlet: Capillary
Gas control module: 2 sets
Injection mode: liquid autosampler
Column: HP-5
Workstation: Optima-3007

Peak sequence: α -BHC, β -BHC, γ -BHC, δ -BHC, op-DDE, pp-DDD, op-DDT, pp-DDT

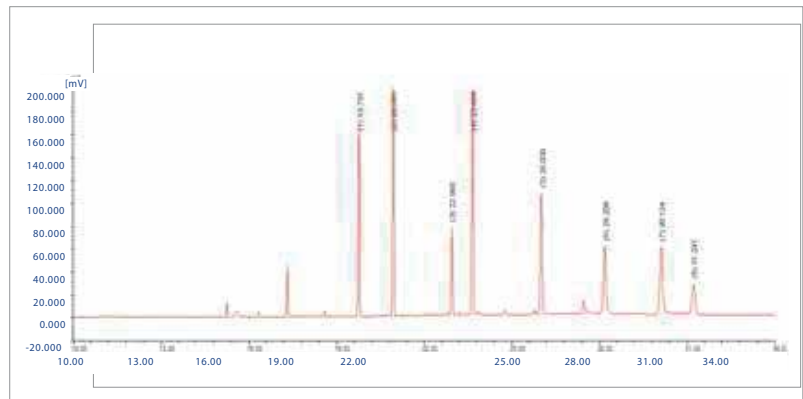

100ppb organophosphoruspesticideresidue

Setup

Detector: FPD
Inlet: Capillary
Gas control module: 2 sets
Injection mode: liquid autosampler
Column: DB-35
Workstation: Optima-3007

Peak sequence: DDVP, methamidophos, acephate, omethoate, dimethoate, parathionmethyl, fenitrothion, parathion, quinalphos, tiguron triazophos

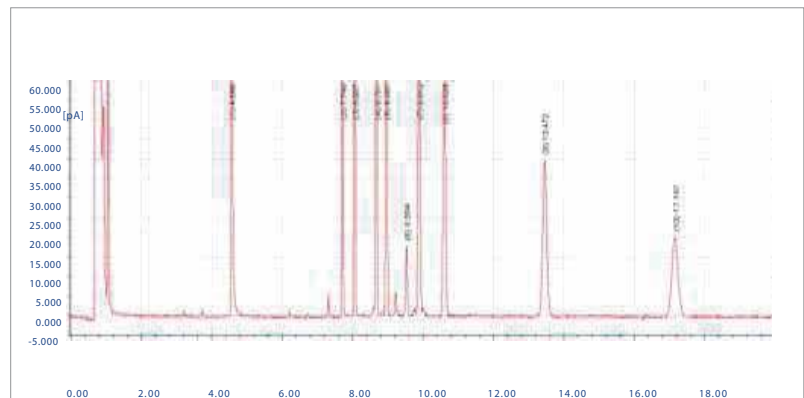

Complicated Organochlorine

Setup

Detector: ECD
Inlet: Capillary
Gas control module: 2 sets
Injection mode: liquid autosampler
Column: HP-5
Workstation: Optima-3007

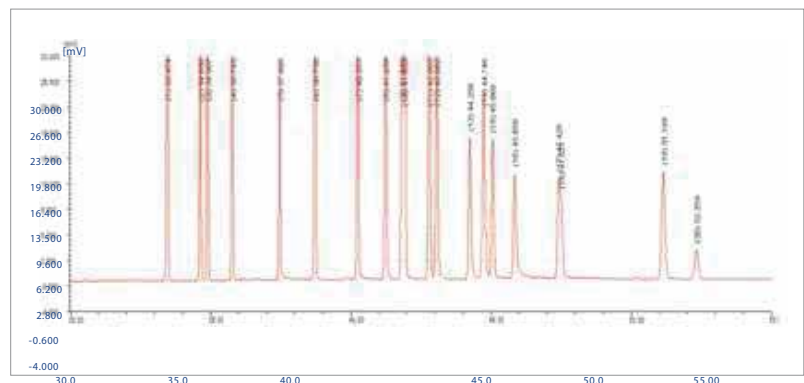

【Environmental protection】

Setup

Detector: TCD
 Inlet: Packed
 Gas control module: 2 sets
 Injection mode: liquid autosampler
 Column: Hayesep Q
 Workstation: Optima-3007

Peak sequence: COS, CS₂, SO₂, Methyl Mercaptan, Ethyl Mercaptan

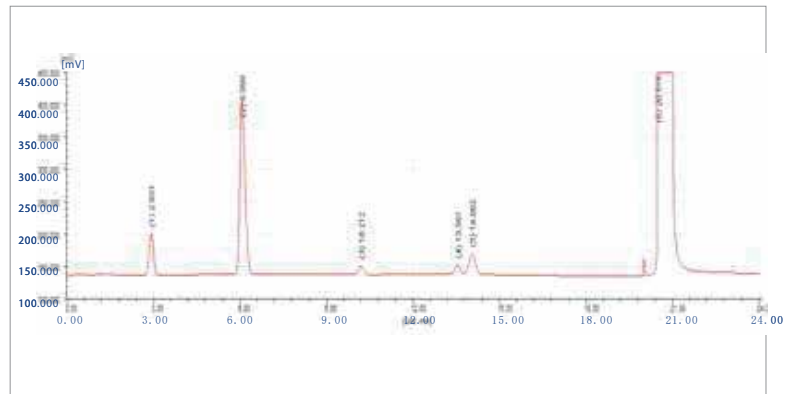

Setup

Detector: ECD
 Inlet: Capillary
 Gas control module: 2 sets
 Injection mode: liquid autosampler
 Column: DM-1
 Workstation: Optima-3007

Peak sequence: CHCl₃, CCl₄

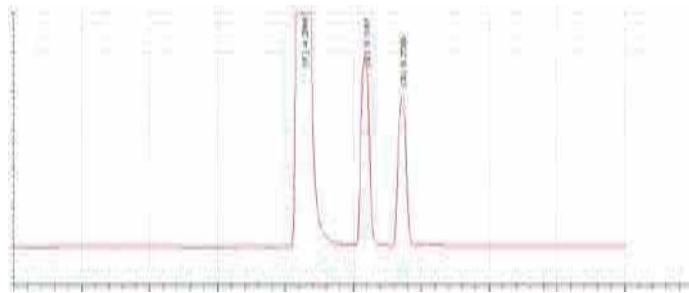

【Energy】

Setup

Detector: FID+TOC
 Injector: gas/capillary

4-valve-5-column
 Gas control module: 4sets
 Valve injection

Column: Hayesep Q packed, 5A packed,
 Al₂O₃ capillary, DB-1 capillary
 Workstation: GC-3007

Inorganic gas peak sequence: H₂, CO₂, O₂, N₂, CO

Hydrocarbon peak sequence: CH₄, C₂H₆, C₂H₄, C₃H₆, C₃H₈, cyclopropane, C₂H₂, iso-butane,
 Propadiene, n-butane, trans-2-Butene,, n-butylene, isobutene, cis-2-Butene, isopentane, n-pentane,
 allylene, 1,3-butadiene, 2-methyl-2-butene, trans-2-Pentene, 1-pentene, cis-2-Pentene, Hexane

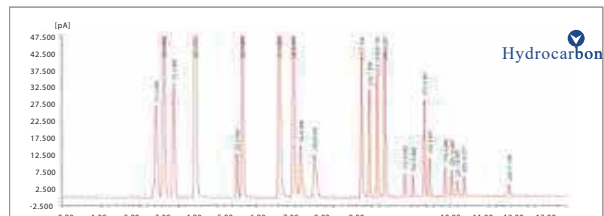
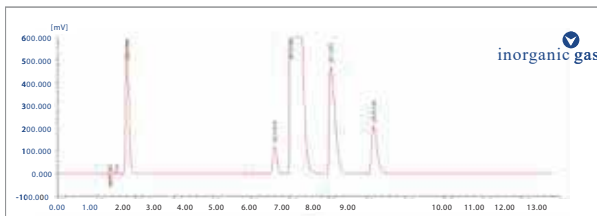

Distillationsimulation

Setup

Detector: FID
 Inlet: Capillary
 Gas control module: 2 sets
 Injection mode: liquid autosampler
 Column: HP-1 cap.
 Workstation: GC-3007

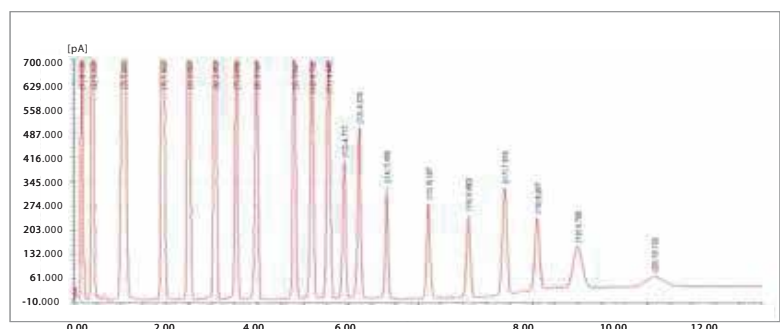

Aromatic compounds

Setup

Detector: FID
 Inlet: Capillary
 Gas control module: 2 sets
 Injection mode: liquid autosampler
 Column: Innowax cap.
 Workstation: Optima-3007

Peak sequence: Benzene, Toluene, Ethane, P-xylene, M-xylene, P-Ethyltoluene, M-Ethyltoluene, S-Butylbenzene, Diethylbenzene, O-diethylbenzene

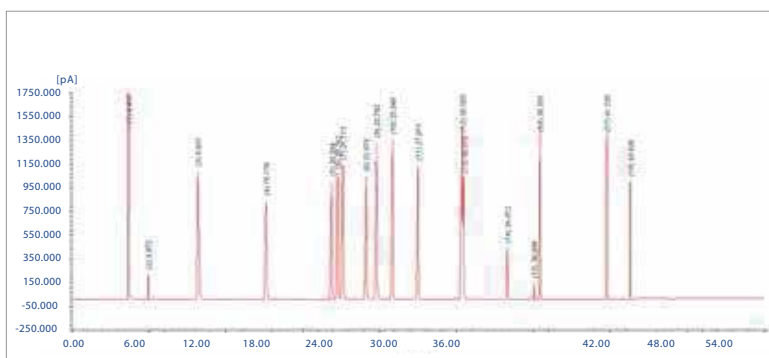

Dimethyl ether in LNG

Setup

Detector: FID
 Inlet: Capillary
 Gas control module: 2 sets
 Injection mode: Gas valve injection
 Column: PLOTQ cap.
 Workstation: Optima-3007

Peak sequence: CH₄, C₂H₂, prepene, propane, methylal, Dimethyl ether, n-butene, cis-bitene, isoamylene, methyl alcohol, n-pentane

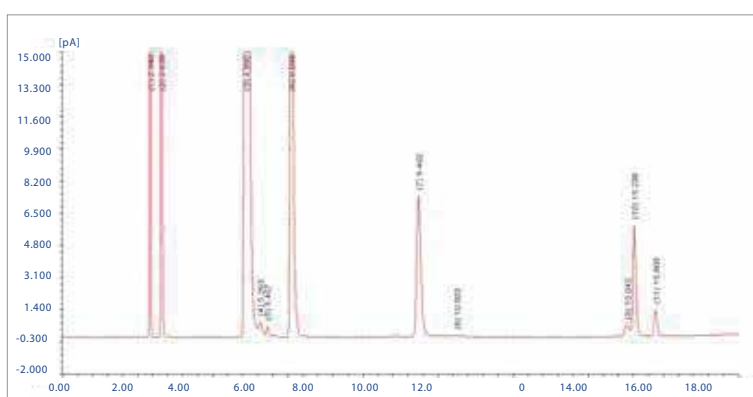

[Medicine]

Organic acid

Setup

Detector: FID
 Inlet: Capillary
 Gas control module: 2 sets
 Injection mode: liquid autosampler
 Column: DB-FFAP
 Workstation: Optima-3007

Peak sequence: acetic acid, propionic acid, butyrate, valeric acid, sovaleric acid, caproic acid, heptylic acid, octanoic acid, n-nonanoic acid, lactic acid, 2-Hydroxy-2-Methylbutyric Acid.

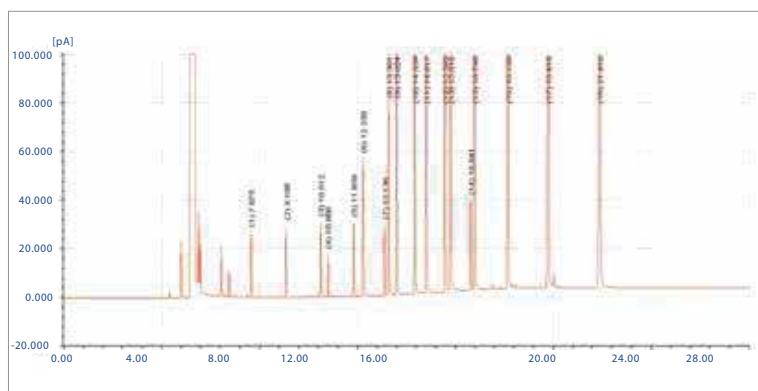

Cresolisomer

Setup

Detector: FID
 Inlet: Capillary
 Gas control module: 2 sets
 Injection mode: liquid autosampler
 Column: specialized for cresol
 Workstation: Optima-3007

Peak sequence: o-cresol, p-cresol, m-cresol

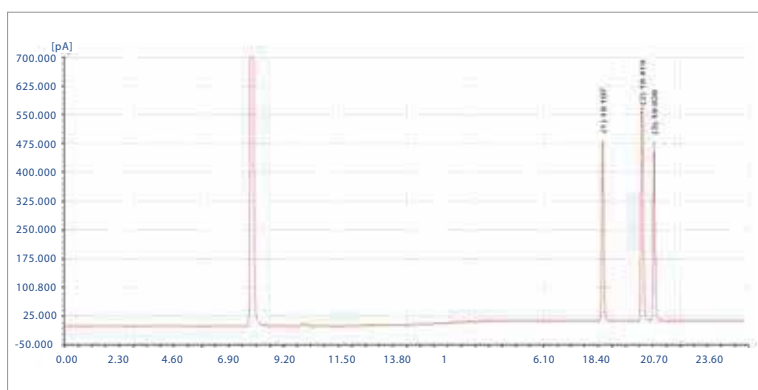

Organic solvent:

Setup

Detector: FPD
 Inlet: Capillary
 Gas control module: 2 sets
 Injection mode: liquid autosampler
 Column: DB-624 cap.
 Workstation: Optima-3007

Peak sequence: methyl alcohol, ethanol, acetone+ isopropanol, acetonitrile, dichloromethane, chloroform, isobutanol, CCl₄, Benzene, n-heptane, isoamylol, pyridine, toluene, n-amyl alcohol, ethylbenzene, p-xylene, n-Hexanol, o-xylene

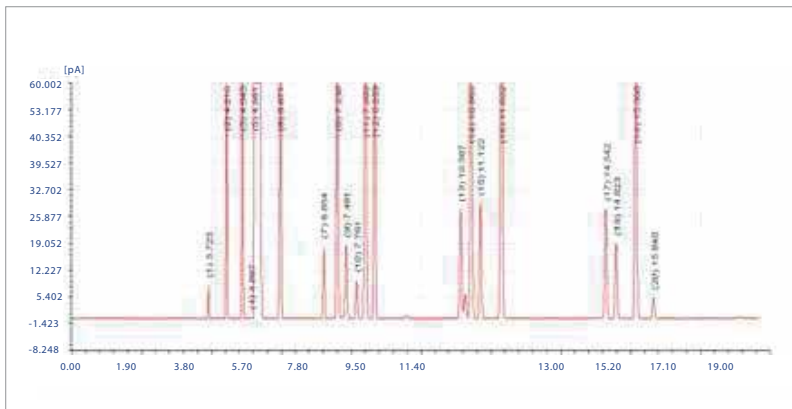

VOCS2nd-level solution

Setup

Detector: FPD
 Inlet: Capillary
 Gas control module: 2 sets
 Injection mode: liquid autosampler
 Column: PC-VOCOL
 Workstation: Optima-3007

Peak sequence: methanol, ethanol, isopropanol, acetone, methyl acetate, n-butyl alcohol, butanone, ethyl acetate, acetic acid isopropyl ester benzene, 1-Methoxy-2-propanol, propyl acetat, 4-methyl-2-pentanone, 1-Ethoxy-2-propanol, toluene, n-butyl acetate, ethylbenzene, o-xylene, styrene

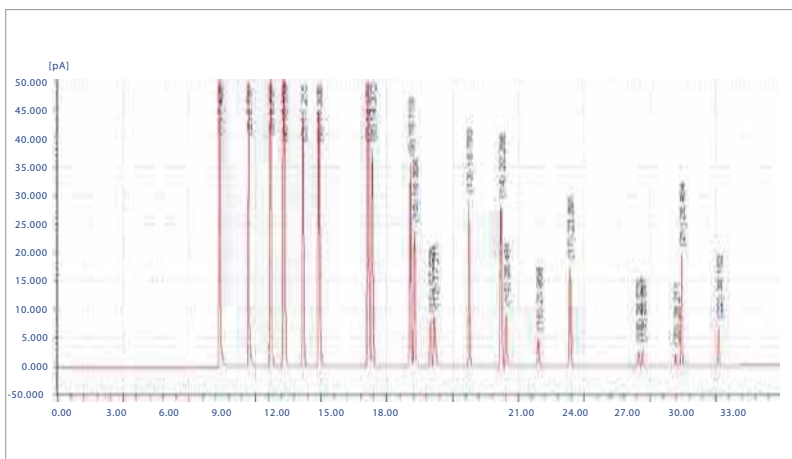

50ppb thiopheneinBenzene

Setup

Detector: FPD
 Inlet: Capillary
 Gas control module: 2 sets
 Injection mode: liquid autosampler
 Column: HP-Innowax
 Workstation: Optima-3007

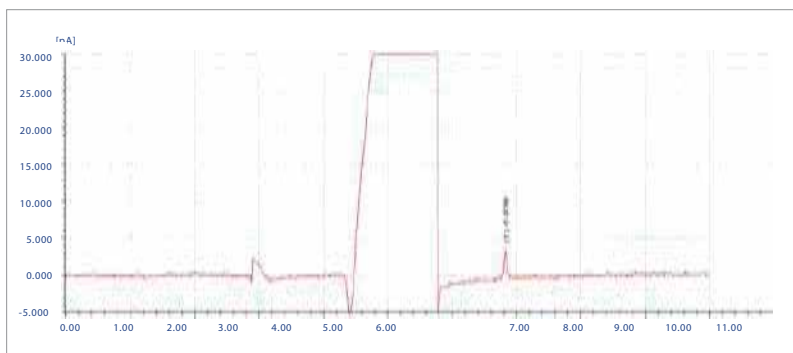

HPLC Servicing, Validation, Trainings and Preventive Maintenance :

HPLC Servicing :HPLC Servicing : We have team of service engineers who can attend to any make of HPLC promptly @the most affordable cost.

Trainings :We also take up preventive Maintenance to reduce downtime of HPLC's Trainings.

AMC's/CMC :AMC's/CMC :We offer user training both in-House and at customer sites on HPLC principles, operations, trouble-shooting.

Validations :Validations :We have protocols for carrying out periodic Validations as per GLP/GMP/USFDA norms.

Instruments :Instruments :We offer instruments/Renting Services Modules like pumps,detector etc. on Rent.



About Analytical Technologies

Analytical Technologies is synonymous for offering technologies for doing analysis and is the Fastest Growing Global Brand having presence in at least 96 countries across the global. Analytical Technologies Limited is an ISO:9001 Certified Company engaged in Designing, Manufacturing, Marketing & providing Services for the Analytical, Chromatography, Spectroscopy, Bio Technology, Bio Medical, Clinical Diagnostics, Material Science & General Laboratory Instrumentation. Analytical Technologies, India has across the Country operations with at least 4 Regional Offices, 6 Branch Offices & Service Centers. Distributors & Channel partners worldwide.

Our Products & Technologies



UV/VIS
Spectro 2080+
Double Beam



Infra FTIR



Optima Gas
Chromatograph
3007



Optima Gas
Chromatograph
2979 Plus



Flash
Chromatograph



Atomic Absorption
Spectrophotometer



Liquid Particle
Counter



Optical Emission
Spectrophotometer

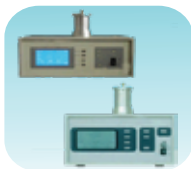

DSC/TGA



Semi Auto Bio
Chemistry Analyzer



HEMA 2062
Hematology
Analyzer



Micro Plate
Reader/Washer



URINOVA 2800
Urine Analyzer



Total Organic
Carbon 3800



Fully Automated
CLIA



NOVA-2100
Chemistry Analyzer



PCR/Gradient PCR/
RTPCR



TOC
Analyzer



Laser Particle
Size Analyzer



Ion Chromatograph



Water purification
system

Regulatory compliances



Corporate Social Responsibility

Analytical Foundation is a nonprofit organization (NGO) found for the purpose of:



Analytical Foundation

1. Research & Innovation Scientist's awards/QC Professional Award : Quality life is possible by innovation only and the innovation is possible by research only, hence ANALYTICAL FOUNDATION is committed to identify such personalities for their contributions across various field of Science and Technology and awarding them yearly. To participate for award, send us your details of research / testing / publication at Info@analyticalfoundation.org

2. Improving quality of life by offering YOGA Training courses, Work shops/Seminars etc.

3. ANALYTICAL FOUNDATION aims to DETOXIFY human minds,souls and body by means of yoga, Meditation, Ayurveda, Health Care, Awards, Media, Events, Camps etc.

Reach us @



HPLC Solutions MultipleLabs Analytical Bio-Med Analytical Distributors Analytical Foundation (Trust)

Corporate & Regd. Office:
Analytical House, # E67 & E68,
Ravi Park, Vasna Road, Baroda,
Gujarat 390 015. INDIA

T: +91 265 2253620
+91 265 2252839
+91 265 2252370
F: +91 265 2254395

E: info@hplctechnologies.com
info@multiplelabs.com
info@analyticalgroup.net
info@analyticalbiomed.com

W. www.analyticalgroup.net
www.hplctechnologies.com
www.multiplelabs.com
www.ais-india.com

Sales & Support Offices:
across the country :
Distributors & Channel
partners World Wide

Note : Company reserves rights to add/delete/modify the contents / technical specifications of the catalogue without prior notice.